



Serie B4MASK / B4MASK series



Caratteristiche principali / Main features

- Grado di protezione IP65
- Disponibile commutatore con O centrale
- Luminoso o non luminoso
- IP65 protection degree
- Intermediate switch with central O available
- Illuminated or not

Schemi elettrici disponibili / Wiring diagrams available

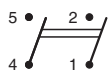

Interruttore bipolare
Double-pole switch

Pag 90

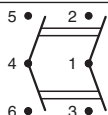

Commutatore bipolare
Double-pole intermediate switch

Pag 90

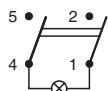

Interruttore bipolare luminoso
Illuminated double-pole switch

Pag 91

Accessori: connettore per cablaggio
Accessories: wiring connector

Pag 92

Caratteristiche elettriche / Electrical features

Portata <i>Electrical rating</i>	Fino a 16 (8) A <i>Up to 16(8) A</i>
Numero cicli elettromeccanici <i>Electro-mechanical cycles number</i>	Fino a 50.000 <i>Up to 50.000</i>
Temperatura ambiente <i>Room temperature</i>	Fino a 120°C <i>Up to 120°C</i>
Infiammabilità <i>Flammability</i>	UL 94 V-2
Resistenza al calore e al fuoco <i>Heat and fire resistance</i>	GWFI 850 °C and GWIT 775°C (on demand)
Distanza tra i contatti <i>Contact gap</i>	≥ 3mm
Marchi di approvazione <i>Approval Marks</i>	
Normative di riferimento <i>Reference Standards</i>	EN61058-1 UL1054
Grado IP <i>IP degree</i>	IP65

Dima / Cut out

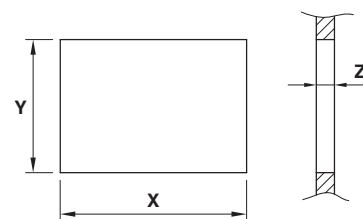







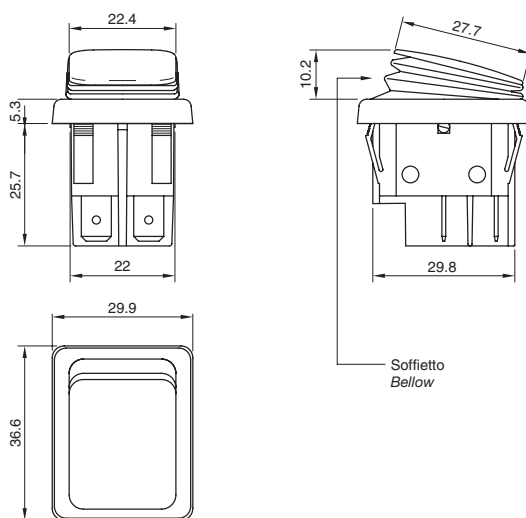
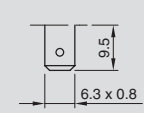



Z	Y	X
0.7 ... 1.25	22.0 ^{+0.2} ₀	30.2 ± 0.1
1.25 ... 2.0	22.0 ^{+0.2} ₀	30.6 ± 0.1
2.0 ... 3.0	22.0 ^{+0.2} ₀	30.8 ± 0.1







Su richiesta disponibile con portata:
On demand, the following rating is available:
20 (10) A / 250VAC - 14 (14) A / 250VAC - 5E4







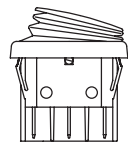







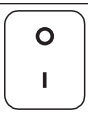

Dimensioni e tipologie di terminali / Dimensions and terminal types

Disegno <i>Drawing</i>	Tipo terminale <i>Terminal type</i>
	

Nota. Per il tasto esistono due versioni: lucido e satinato
Note. Two rockers models available: gloss- and mat-finished

 INTERRUTTORE BIPOLARE / DOUBLE-POLE SWITCH					
Portata Rating	Terminale Terminal	Soffietto Bellow	Tasto Rocker	Codice P/N Code	Tipo Type
16 (8) A / 250VAC 12 (10) A / 250VAC E4 T120/55 °C 20A - 125 VAC 16A - 250 VAC 3/4 HP - 125 VAC 3/4 HP - 250 VAC T 105°C				B4MASK42N1100000	Tasto lucido Gloss-finished rocker
				B4MASK42N1121000	
				B4MASK42N7721000	
				B4MASK52N1121000	Tasto satinato Mat-finished rocker

 COMMUTATORE BIPOLARE DOUBLE-POLE INTERMEDIATE SWITCH					
Portata Rating	Terminale Terminal	Colore corpo Body colour	Tasto Rocker	Codice P/N Code	Tipo Type
16 (8) A / 250VAC 12 (10) A / 250VAC E4 T120/55 °C 20A - 125 VAC 16A - 250 VAC 3/4 HP - 125 VAC 3/4 HP - 250 VAC - 105°C	1 			B4MASK19C1100000	
				B4MASK19C112A000	
				B4MASK19C1129000	

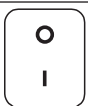
 INTERRUTTORE BIPOLARE LUMINOSO / ILLUMINATED DOUBLE-POLE SWITCH					
Portata Rating	Terminale Terminal	Soffietto Bellow	Tasto Rocker	Codice P/N Code	Tipo Type
16 (8) A / 250VAC 12 (10) A / 250VAC E4 T120/55 °C 20A - 125 VAC 16A - 250 VAC 3/4 HP - 125 VAC 3/4 HP - 250 VAC T 105°C				B4MASK48N1E21000	Tasto lucido <i>Gloss-finished rocker</i>
				B4MASK48N1G00000	
				B4MASK48N1G21000	
				B4MASK48N1F21000	
				B4MASK48N1L11000	
			 *	B4MASK48N1V11000	
			 *	B4MASK48N1R00000	
			 *	B4MASK48N1R11000	
			 *	B4MASK48N1A00000	
			 *	B4MASK48N1A11000	
20 (10) A / 250VAC 14 (10) A / 250VAC 5E4 T120/55 °C 3/4 HP - 125/250 VAC 25A / 125VAC 16A / 250VAC T 105°C				B4MASK48S1E21000	
				B4MASK48S1G21000	
				B4MASK48S1L11000	

[*] Colore brillante / *Bright colour*

Accessorio: connettore per cablaggio / Accessory: wiring connector

B4CNT

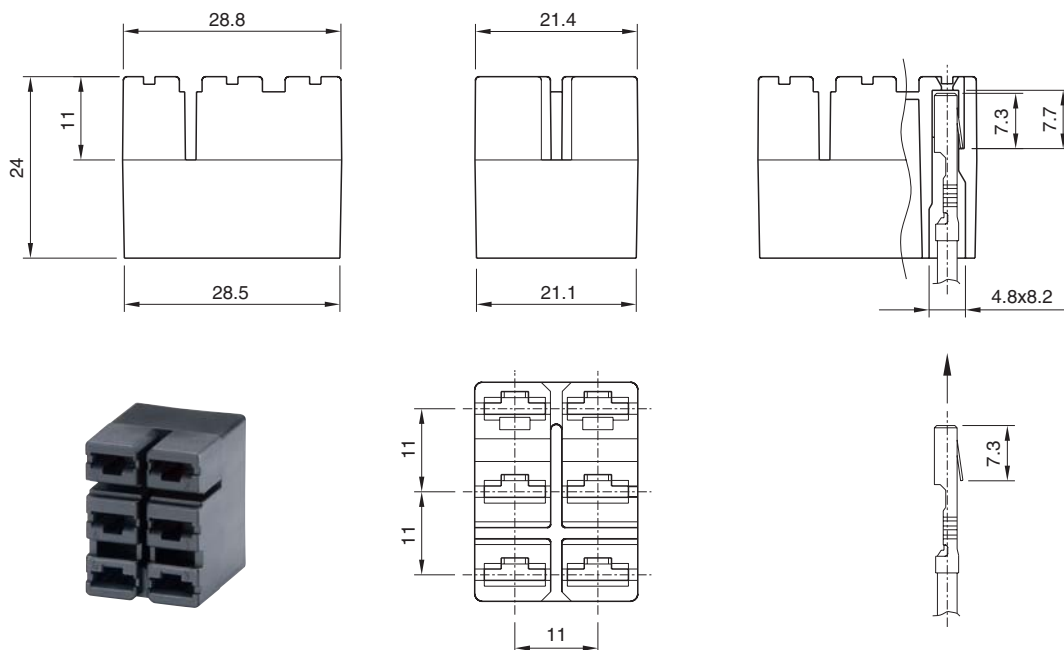

Su richiesta, il tasto può presentare le seguenti marcature
On demand the rocker can be customized with the following markings

