



Serie A8 / A8 series



Caratteristiche principali / Main features

- Luminoso o non luminoso
- Estetica simile a serie interruttori A1 e a serie segnalatori A5
- Bipolare
- Illuminated or not
- Esthetics similar to A1 switches series and A5 signals light series
- Double-pole

Schemi elettrici disponibili / Wiring diagrams available

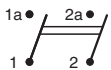

Interruttore bipolare
Double-pole switch

Pag 44

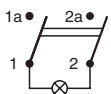

Interruttore bipolare luminoso
Illuminated double-pole switch

Pag 44

Accessori: cappucci antispruzzo
Accessories: splash water caps

Pag 45

Caratteristiche elettriche / Electrical features

Portata <i>Electrical rating</i>	Fino a 10 (4) A <i>Up to 10(4) A</i>
Numero cicli elettromeccanici <i>Electro-mechanical cycles number</i>	Fino a 50.000 <i>Up to 50.000</i>
Temperatura ambiente <i>Room temperature</i>	Fino a 125°C <i>Up to 125°C</i>
Infiammabilità <i>Flammability</i>	UL 94 V-2
Resistenza al calore e al fuoco <i>Heat and fire resistance</i>	GWFI 850 °C and GWIT 775°C (on demand)
Distanza tra i contatti <i>Contact gap</i>	≥ 3mm
Marchi di approvazione <i>Approval Marks</i>	
Normative di riferimento <i>Reference Standards</i>	EN61058-1 UL1054

Dima - Cut out

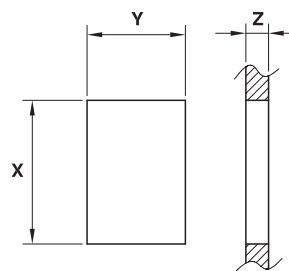





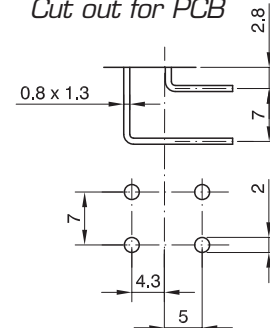

Z	Y	X
0.7 ... 1.25	13.0 ± 0.1	19.0 + 0.2
1.25 ... 2	13.0 ± 0.1	19.3 + 0.2
2.0 ... 3	13.0 ± 0.1	19.6 + 0.2

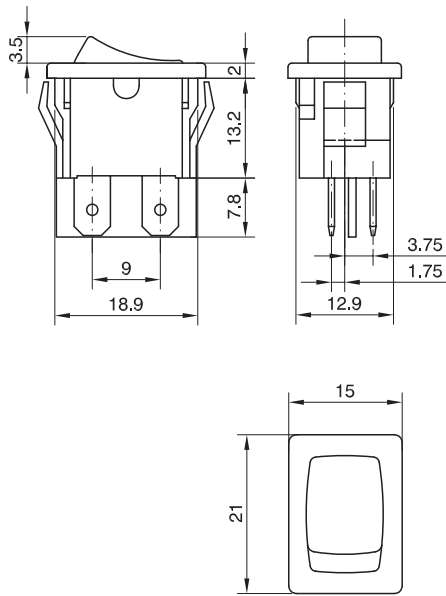
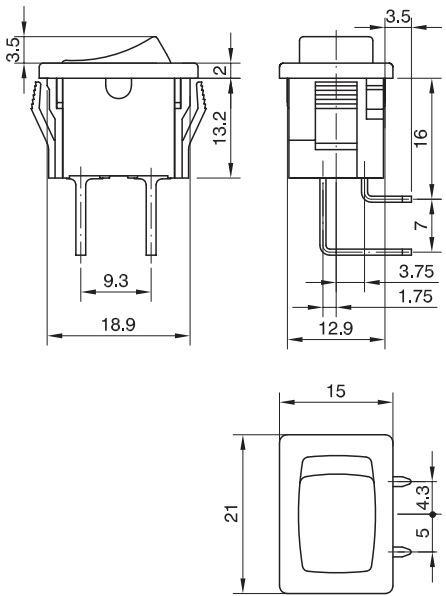





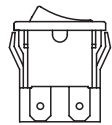





Dima di foratura per saldatura su circuito stampato *Cut out for PCB*

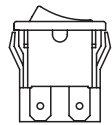

Dimensioni e tipologie di terminali / Dimensions and terminal types

Disegno <i>Drawing</i>	Tipo terminale <i>Terminal type</i>	Disegno <i>Drawing</i>	Tipo terminale <i>Terminal type</i>
	1		C

 INTERRUTTORE BIPOLARE / DOUBLE-POLE SWITCH					
Portata Rating	Terminale Terminal	Colore corpo Body colour	Tasto Rocker	Codice P/N Code	Tipo Type
10 (4) A / 250VAC 6 (4) A / 250VAC 5E4 T125 °C 10A / 125 - 250 VAC 1/2 HP - 125 VAC 1/3 HP - 250 VAC T 65°C	1 			A81231100000	
				A81231121000	
				A81231124000	

 INTERRUTTORE BIPOLARE LUMINOSO / ILLUMINATED DOUBLE-POLE SWITCH					
Portata Rating	Terminale Terminal	Colore corpo Body colour	Tasto Rocker	Codice P/N Code	Tipo Type
10 (4) A / 250VAC 6 (4) A / 250VAC 5E4 T125 °C 10A / 125 - 250 VAC 1/2 HP - 125 VAC 1/3 HP - 250 VAC T 65°C	1 			A81831E00000	
				A81831E26000	
				A81831G00000	
				A81831G26000	
				A81831H26000	
				A81832E26000	
				A81832H26000	

Accessori: cappucci antispruzzo / Accessories: splash water caps

A1CAP	A3CAP

A1PRT	
Colore Colour	Codice Code
■	A1PRT1
□	A1PRT2